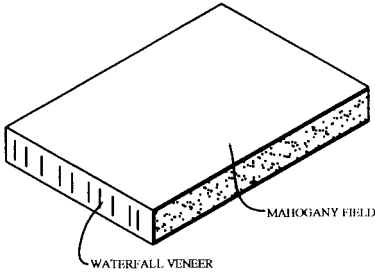
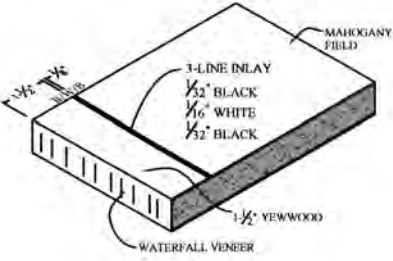
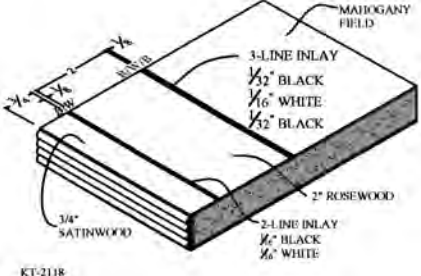
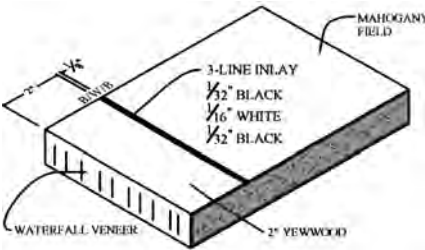
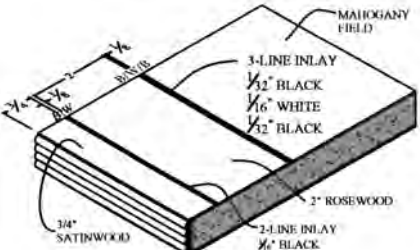
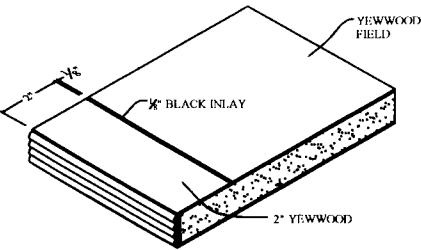
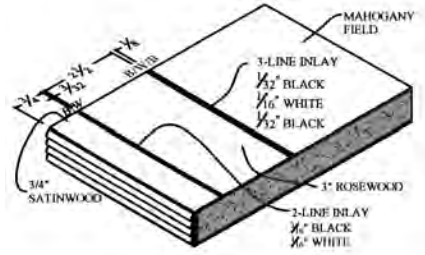
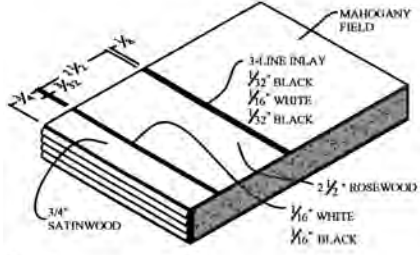
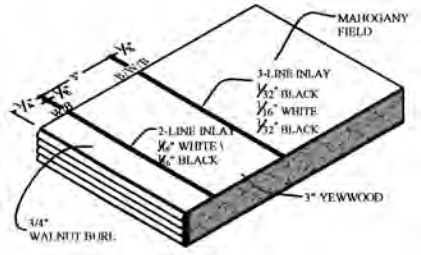
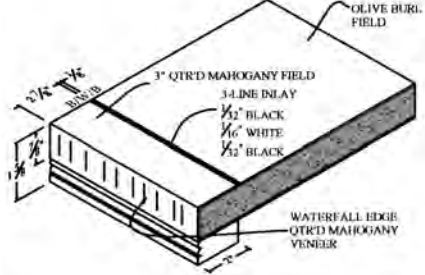
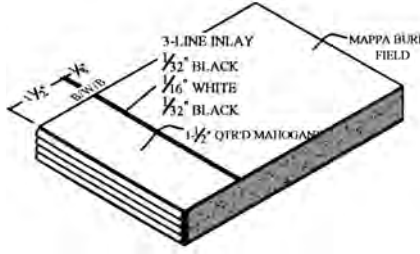
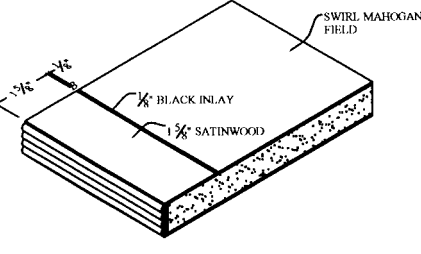

TABLE BANDING DETAILS

 <p>MAHOAGANY FIELD WATERFALL VENEER</p> <p>KT2107</p>	 <p>MAHOAGANY FIELD 3-LINE INLAY 1/32" BLACK 1/16" WHITE 1/32" BLACK 1 1/2" YEWOOD WATERFALL VENEER</p> <p>KT2108</p>	 <p>MAHOAGANY FIELD 3-LINE INLAY 1/32" BLACK 1/16" WHITE 1/32" BLACK 2" ROSEWOOD 3/4" SATINWOOD 2-LINE INLAY 1/8" BLACK 1/8" WHITE</p> <p>KT-2118</p> <p>KT2115</p>
 <p>MAHOAGANY FIELD 3-LINE INLAY 1/32" BLACK 1/16" WHITE 1/32" BLACK 2" YEWOOD WATERFALL VENEER</p> <p>KT2116</p>	 <p>MAHOAGANY FIELD 3-LINE INLAY 1/32" BLACK 1/16" WHITE 1/32" BLACK 2" ROSEWOOD 3/4" SATINWOOD 2-LINE INLAY 1/8" BLACK 1/8" WHITE</p> <p>KT2118</p>	 <p>YEWOOD FIELD 1/8" BLACK INLAY 2" YEWOOD</p> <p>KT2119</p>
 <p>MAHOAGANY FIELD 3-LINE INLAY 1/32" BLACK 1/16" WHITE 1/32" BLACK 3" ROSEWOOD 3/4" SATINWOOD 2-LINE INLAY 1/8" BLACK 1/8" WHITE</p> <p>KT2120 / KT2121</p>	 <p>MAHOAGANY FIELD 3-LINE INLAY 1/32" BLACK 1/16" WHITE 1/32" BLACK 2 1/2" ROSEWOOD 3/4" SATINWOOD 1/16" WHITE 1/16" BLACK</p> <p>KT-2122</p> <p>KT2122</p>	 <p>MAHOAGANY FIELD 3-LINE INLAY 1/32" BLACK 1/16" WHITE 1/32" BLACK 2-LINE INLAY 1/8" WHITE 1/8" BLACK 3" YEWOOD 3/4" WALNUT BURL</p> <p>KT2130</p>
 <p>OLIVE BURL FIELD 3" QTR'D MAHOAGANY FIELD 3-LINE INLAY 1/32" BLACK 1/16" WHITE 1/32" BLACK WATERFALL EDGE QTR'D MAHOAGANY VENEER</p> <p>KT2140</p>	 <p>MAPPA BURL FIELD 3-LINE INLAY 1/32" BLACK 1/16" WHITE 1/32" BLACK 1 1/2" QTR'D MAHOAGANY</p> <p>KT2150</p>	 <p>SWIRL MAHOAGANY FIELD 1/8" BLACK INLAY 1 1/8" SATINWOOD</p> <p>R11-3201 & 3202 & 3221</p> <p>KT3201</p>

CONFERENCE TABLES

CUSTOM DESIGNS AND CONFERENCE TABLES

Our Kittinger sales representative and dealer can show you many options available to fit your exact needs. They'll work with you in selecting top size and shape, veneer, banding, inlay, edge treatments and base style. Our customs department takes this input and develops a design in keeping with Kittinger's standards of excellence. This process involves an ongoing exchange of ideas between Kittinger's designers and the customer until a satisfactory design is developed.

The design then goes to our Engineering Department for technical input. After the customer approves the final drawing, it is sent to the plant where the pieces are constructed. The result is custom designed furniture, which provides years of timeless beauty and elegance.

The following pages illustrate the various components to make up our conference table program.

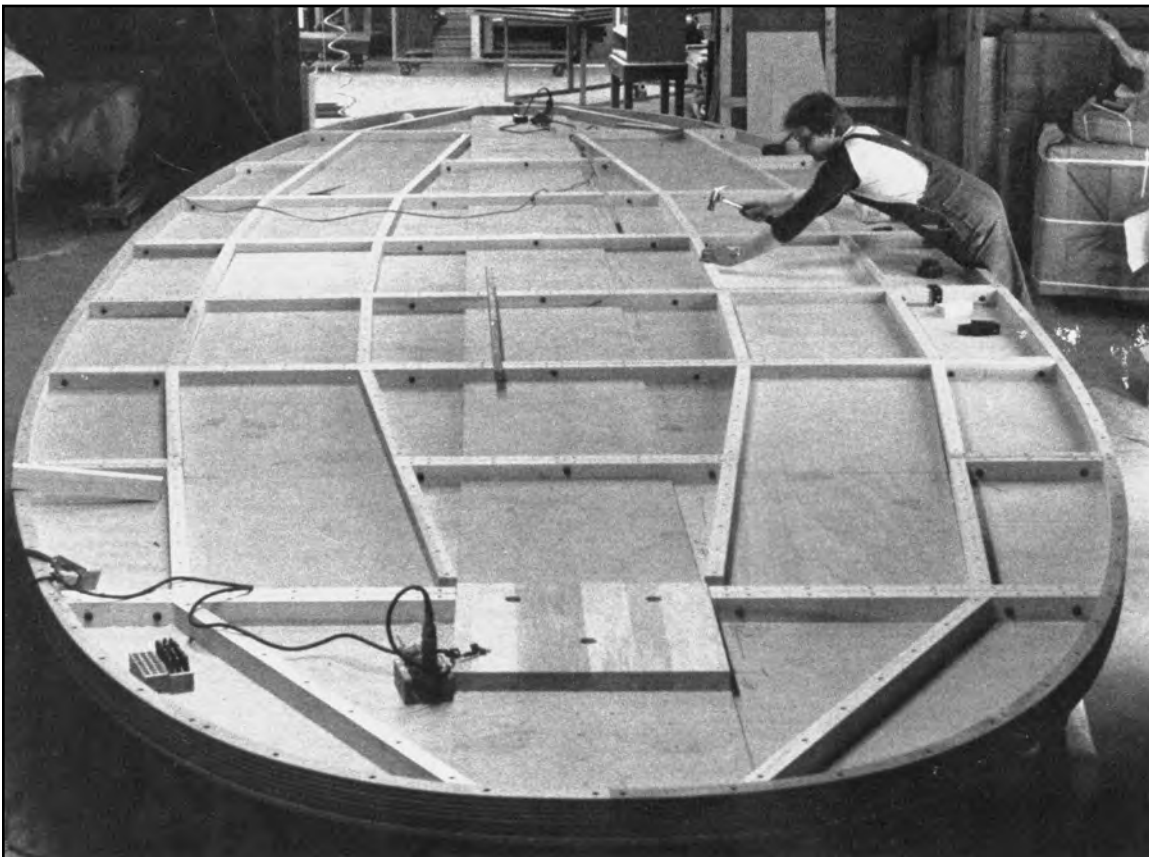

Maple cleating layout on underside of 9-section 36'x12' table for the summit conference at Williamsburg, Virginia. Craftsman shown stamping identification numbers to ensure proper set-up.

TOP SHAPES AND EXAMPLES OF TABLE CONFIGURATIONS

Choose a conference table in any size for any purpose. Each table, constructed from select mahogany and mahogany veneers, is available in a variety of rich shades and finishes.

The following illustrations are examples of potential top shapes and base selections for custom conference tables. Structural cleating has been left off sketches for clarity.

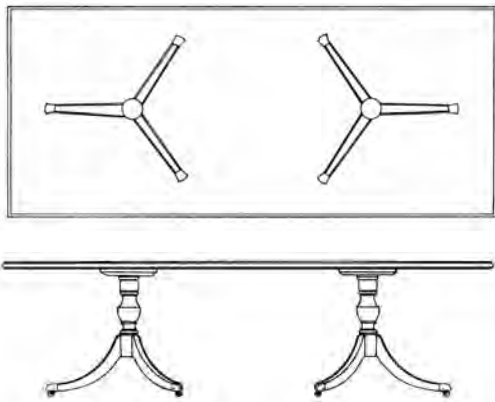

Rectangular top with bullnose edge and two KT-8503 (3-sweep) bases.

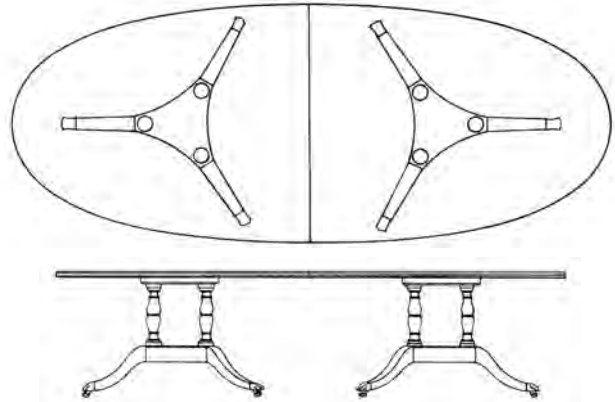

Oval top with reeded edge and two KT-8506 (3-sweep) bases.

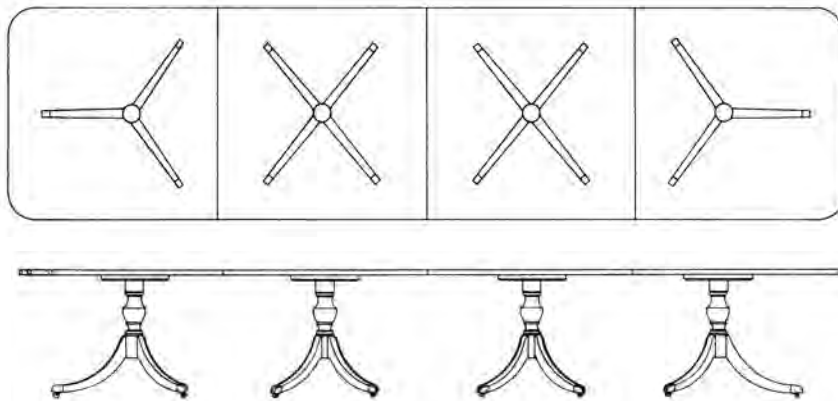

Rectangular top with rounded corners, square veneered edge, two KT-8503 (3-sweep) bases, and two KT-8603 (4-sweep) bases.

CONFERENCE TABLE

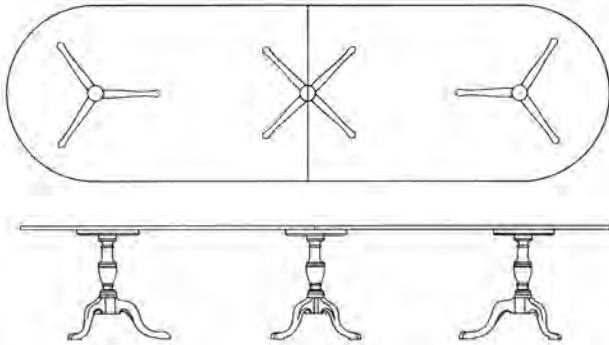

Rectangular top with half-round ends, two KT-8508 (3-sweep) bases and one KT-8608 (4-sweep) base.

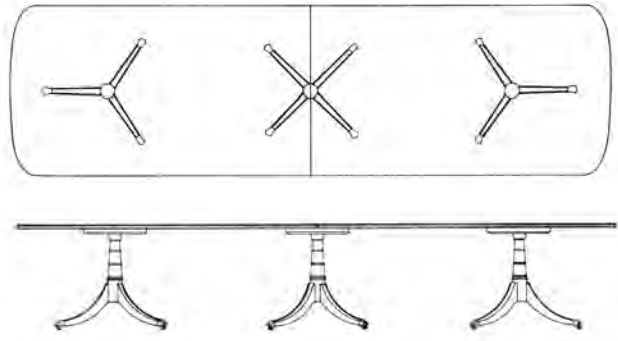

Rectangular top with "D" shaped ends, reeded edge, two KT-8501 (3-sweep) bases, and one KT-8601 (4-sweep) base.

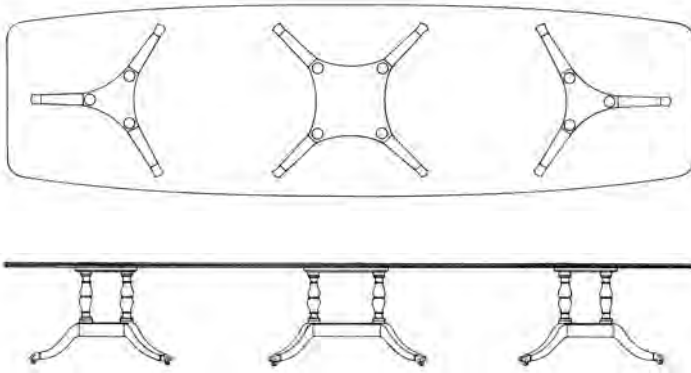

Boat shaped top with "D" shaped ends, bullnose edge, two KT-8506 (3-sweep) bases and one KT-8606 (4-sweep) base.

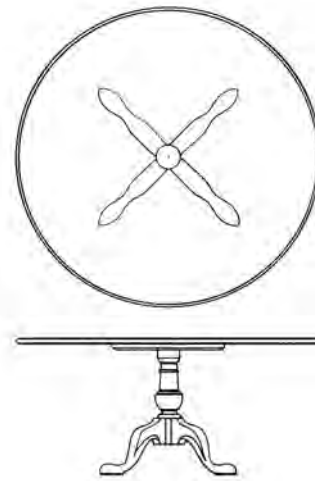

Round top with bullnose edge and one KT-8607 (4-sweep) base.

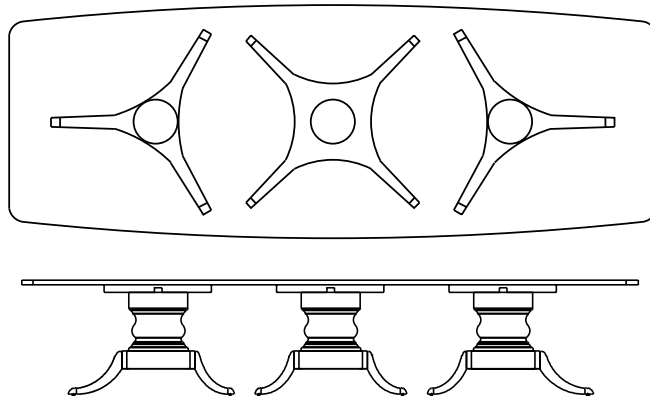

Boat shaped top with rounded corners, reeded edge, two KT-8509 (3-sweep) bases and one KT-8609 (4-sweep) base.

CONFERENCE TABLE TOPS

CONFERENCE TABLE TOPS

Add the following prices to list price.

Width	Style & Pattern Number		List Price	Mahogany banding with 1/8" ebony inlay"			Number of bases required		
	Round	Square		2 1/2	up to 4 1/2"	up to 6"	3 sweep	4 sweep	panel
42"	KT 8301	KT 8401							
48"	KT 8302	KT 8402							
54"	KT 8303	KT 8403							
60"	KT 8304	KT 8404							
72"	KT 8305	KT 8405							
84"	KT 8306	KT 8406							

*NOTE: Pricing for other bandings and inlays are available upon request

Dimen- sions	Style & Pattern Number			List Price	Mahogany banding with 1/8" ebony inlay"			Number of bases required		
	Rect- angle	Boat	Oval		2 1/2	up to 4 1/2"	up to 8"	3 sweep	4 sweep	panel
6' x 42"	KT 8011	KT 8111	KT 8211					2	--	N/A
6' x 48"	KT 8012	KT 8112	KT 8212					2	--	N/A
6' x 54"	KT 8013	KT 8113	KT 8213					2	--	N/A
6' x 60"	KT 8014	KT 8114	KT 8214					2	--	N/A
8' x 42"	KT 8021	KT 8121	KT 8221					2	--	N/A
8' x 48"	KT 8022	KT 8122	KT 8222					2	--	N/A
8' x 54"	KT 8023	KT 8123	KT 8223					2	--	N/A
8' x 60"	KT 8024	KT 8124	KT 8224					2	--	N/A
10' x 42"	KT 8031	KT 8131	KT 8231					2	--	N/A
10' x 48"	KT 8032	KT 8132	KT 8232					2	--	2
10' x 54"	KT 8033	KT 8133	KT 8233					2	--	2
10' x 60"	KT 8034	KT 8134	KT 8234					2	--	2
12' x 42"	KT 8041	KT 8141	KT 8241					2	--	N/A
12' x 48"	KT 8042	KT 8142	KT 8242					2	--	2
12' x 54"	KT 8043	KT 8143	KT 8243					2	--	2
12' x 60"	KT 8044	KT 8144	KT 8244					2	--	2
14' x 48"	KT 8042	KT 8142	KT 8241					2	1	3
14' x 54"	KT 8053	KT 8153	KT 8242					2	1	3
14' x 60"	KT 8054	KT 8154	KT 8244					2	1	3
16' x 48"	KT 8062	KT 8162	KT 8262					2	1	3
16' x 54"	KT 8063	KT 8163	KT 8263					2	1	3
16' x 60"	KT 8064	KT 8164	KT 8264					2	1	3
18' x 48"	KT 8072	KT 8172	KT 8272					2	1	3
18' x 54"	KT 8073	KT 8173	KT 8273					2	1	3
18' x 60"	KT 8074	KT 8174	KT 8274					2	1	3
20' x 48"	KT 8082	KT 8182	KT 8282					2	1	4
20' x 54"	KT 8083	KT 8183	KT 8283					2	1	4
20' x 60"	KT 8084	KT 8184	KT 8284					2	1	4
24' x 48"	KT 8092	KT 8192	KT 8292					2	1	4
24' x 54"	KT 8093	KT 8193	KT 8293					2	1	4
24' x 60"	KT 8094	KT 8194	KT 8294					2	1	4

CONFERENCE TABLE BASES

**Pattern Number
3-sweep Base**

- KT 8501 (D103)
- KT 8502 (D1311)
- KT 8503
- KT 8506
- KT 8507 (K1739)
- KT 8508 (K2647)
- KT 8510
- KT 8511
- KT 8512
- KT 8701 (K1670)
- KT 2002-001

**Pattern Number
4-sweep Base**

- KT 8601
- KT 8602
- KT 8603
- KT 8606
- KT 8607 (K1729)
- KT 8608
- KT 8610
- KT 8611 (D2121)
- KT 8612 (K1879)

KT-8501 (D103) (3-sweep)
KT-8601 (4-sweep)

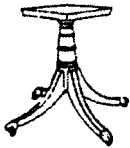

KT-8502 (D1311) (3-sweep)
KT-8602 (4-sweep)

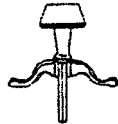

KT-8503 (3-sweep)
KT-8603 (4-sweep)



KT-8506 (3-sweep)
KT-8606 (4-sweep)

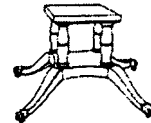

KT-8507 (K1739) (3-sweep)
KT-8607 (K1729) (4-sweep)

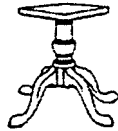

KT-8508 (K2647) (3-sweep)
KT-8608 (4-sweep)



KT-8510 (3-sweep)
KT-8610 (4-sweep)



KT-8511 (3-sweep)
KT-8611 (D2121) (4-sweep)

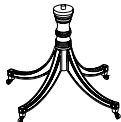

KT-8512 (3-sweep)
KT-8612 (K1879) (4-sweep)



KT-8701 (K1670)

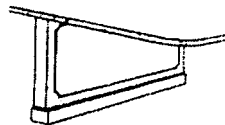

KT 2002-001

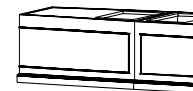

KITTINGER FURNITURE COMPANY

4675 TRANSIT RD • BUFFALO, NY 14221
 PHONE: 716-876-1000 • FAX: 716-837-3989

TABLE SPECIFICATIONS/ORDER SHEET

Customer: _____ Phone: (____) _____

Designer/Architect: _____ Phone: (____) _____

Showroom/Contract Representative: _____ Phone: (____) _____

Choose One: Standard Dining Table Custom Dining Table Custom Conference Table

If this order is for a **STANDARD** Dining Table, please provide Kittinger product number and table leaf information in the spaces provided below and **SKIP TO PAGE 4 OF THIS WORKSHEET.**

Kittinger Product Number: _____

Number of Leaves: _____ Other _____

Width of Leaves: _____ m Other _____

If this order is for a **CUSTOM** Table, please complete this worksheet **IN FULL.**

Please check the table top style you desire:

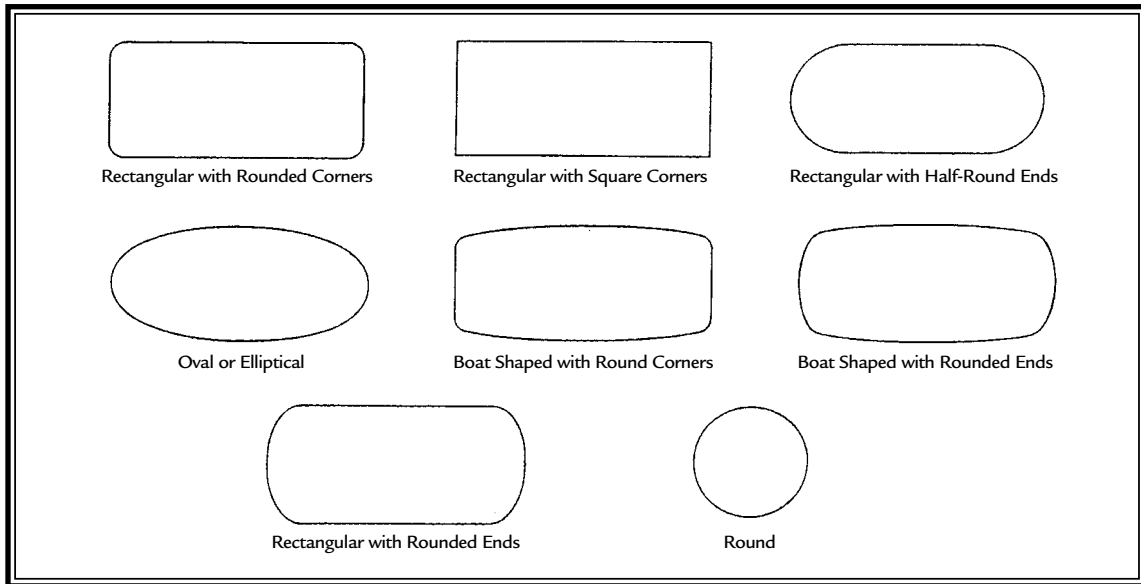

Table Size **without** Leaves: Width _____ inches ; Length _____ inches

Edge Profile: Square Reeded Ogee Bullnose Other _____



Edge Thickness: Standard Dining Table Edge $\frac{7}{8}$ " Standard Conference Table Edge $1\frac{1}{8}$ " Other _____

Apron: YES NO IF YES, Apron Height: 1" 2" 3" 4" Other _____

Number of Data Port Assemblies (please circle): 0 1 2 3 4 5 6 7 8 Other _____

Location of Data Port Assemblies:

Table Top Apron (Table Sides) Apron (Table Ends) Other _____

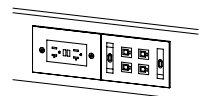

CONFERENCE TABLES

TABLE BASE(S):

Quantity (Circle One): 1 2 3 4 Other _____

Number of Sweeps (Legs) per Base: 3 4 Other _____

Please circle the Kittinger base style you desire:

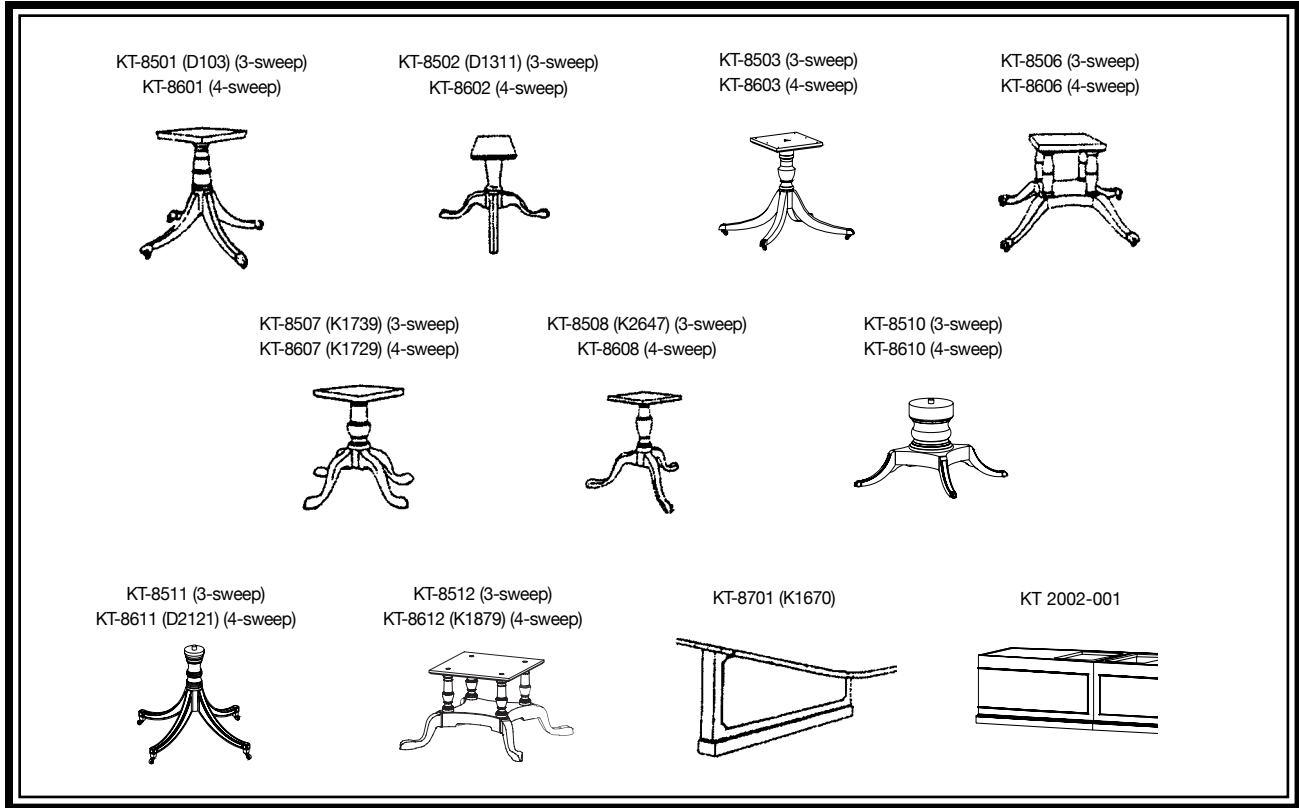

Casters: YES NO (If no casters, levelers come standard.)

Caster Finish: Antique Bright Brass

Choose One: Wood Top Leather Top

(If this order is for a wood top, skip to page 3 of this worksheet).

Type of Leather: Old English: Color: _____ ; Number: _____
 Other _____

Tooling: Gold Blind None

Kittinger Standard Tooling Number: _____

or

Custom: _____

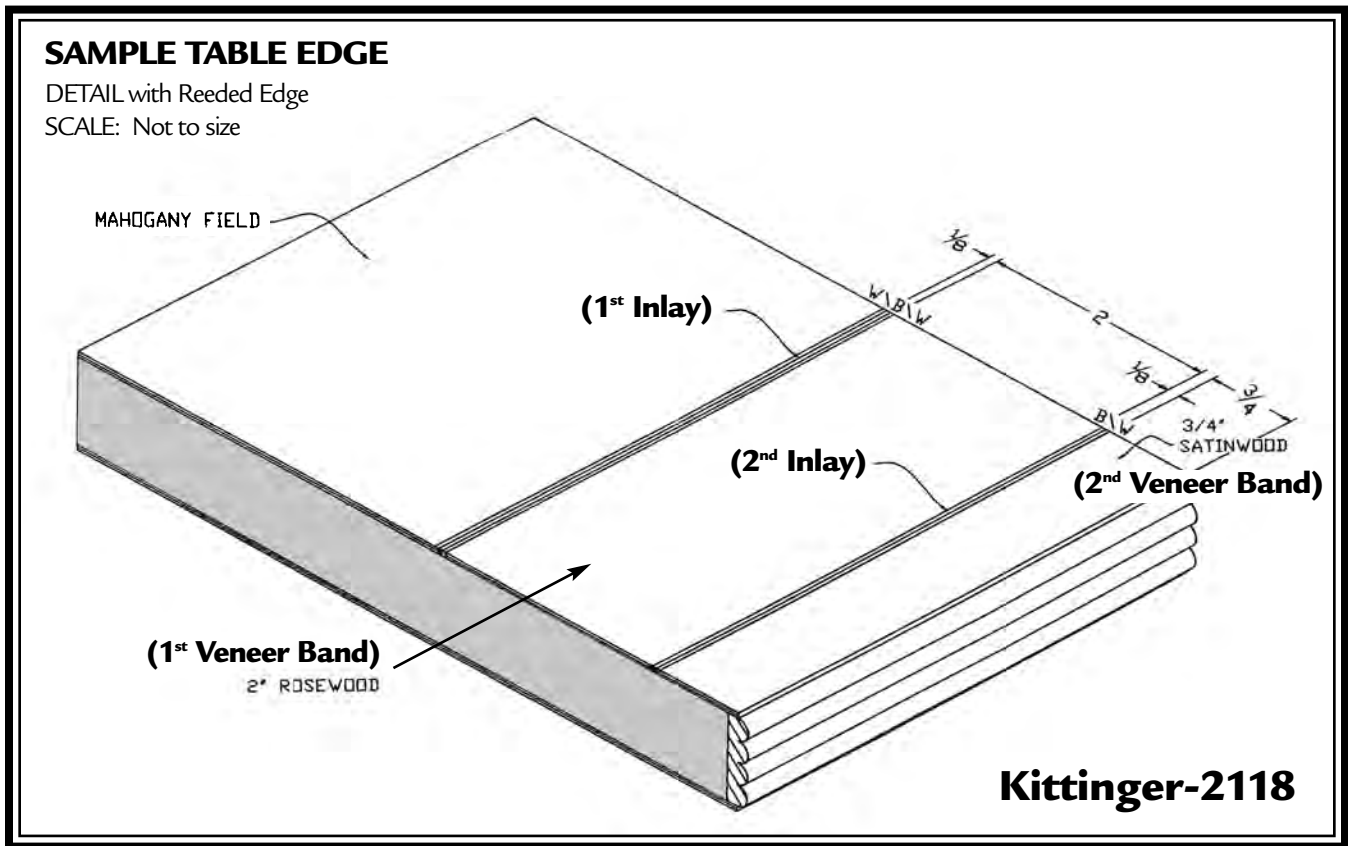

Field Wood: m Figured Mahogany m Swirl Mahogany m Crotch Mahogany m Olive Burl m Other _____

1st Inlay:
(Next to Field) m White m White-Black m White-Black-White
 m Black m Black-White m Black-White-Black
 m Other _____

1st Veneer Band: m Ribbon Mahogany m Swirl Mahogany m Yew Wood m Satin Wood
 m Rose Wood m Walnut Burl m Olive Burl m Other _____

Band Width: m 3/4" m 1" m 1 1/2" m 2" m 2 1/2" m 3" m 3 1/2" m Other _____

2nd Inlay: m White m White-Black m White-Black-White
 m Black m Black-White m Black-White-Black
 m Other _____

2nd Veneer Band:
(Next to Edge) m Ribbon Mahogany m Swirl Mahogany m Yew Wood m Satin Wood
 m Rose Wood m Walnut Burl m Olive Burl m Other _____

Band Width: m 3/4" m 1" m 1 1/2" m 2" m 2 1/2" m 3" m 3 1/2" m Other _____

CATEGORY

PLEASE CHOOSE ONE OPTION IN EACH COLUMN (A, B, C):

FINISH:	A		B			C		
	PORE		GLOSS			STANDING CONTRAST		
	Open	Closed	High	Standard	Dull	Light	Med.	High
Classic Kittinger								
Classic Kittinger Red								
Antique Classic Kittinger								
Old Dominion								
Light Heirloom								
Classic Heirloom								
Dark Heirloom								
Other (Provide Sample to be Matched – \$500 Upcharge)								

Finish Durability Desired: Standard Extra High Durability (\$100 Charge)

Desired Seating Capacity: 4 6 8 10 14 16 18 Other _____

Width Of Chairs Intended To Be Used With Table: _____ inches

Additional Details, Requirements, or Special Requests:

Finish Sample Requested (\$100 Extra Charge): YES NO

TABLE ACCESSORIES DESIRED: (Please See Next Page)

Approval Signature: _____ Date: _____

Print Name Here: _____

For Kittinger Office Personnel

Date specification sheet was received: _____

Date sample will be provided (if requested): _____

Date table will be shipped: _____

Date deposit was received: _____

Table Slides (choose one): Standard / Equalizer / Custom

TABLE ACCESSORIES:

Ship To:

Address: _____

City: _____

State: _____ Zip: _____

Kittinger Product Number (if any): _____

Table Leaf Size: _____ Number of Table Leaves: _____

Please Choose Quality (A, B, or C) and Circle ONE Top and ONE Bottom Color.

A. Elite Table Pad (Includes INTERLOK™ Unless You Check NO) m NO

Specs: 1/2" thick with 550° protection

TOP:

<i>Woodgrain</i>		<i>Contemporary</i>		<i>Leathergrain</i>	
Birch/Monticello	Mt. Vernon	White	Oyster Marble	Sand	Pacific
Wash/Potomac	Cherry/Jefferson	Beige	Moonstone Marble	Cranberry	Forest
Oak/Patriot	Pecan/Capitol	Black	Jade Marble	Slate	Midnight
Colonial	Walnut/Constitution			Chestnut	
Maple/Franklin	Mahogany/Washington				

BOTTOM: Brown Duravel™ Tan Duravel™ Green Duravel™ Black Duravel™ Burgundy Duravel™

B. Select Table Pad

Specs: 3/8" thick with 350° protection

Top: Ant. White Maple Cherry Walnut **Bottom:** Brown Green Tan Black

C. Economy Table Pad

Specs: 1/4" thick with 250° protection

Top: White Maple Brown **Bottom:** Brown Green

D. Table Leaf Storage Bags

18" Qty: _____ 24" Qty: _____ **Circle One:** Vinyl Flannel

Special Instructions or Shipping Information:
